

ALTEZZA DI LAVORO	19,7 m
ALTEZZA PIANO CALPESTIO	17,7 m
SBRACCIO MAX DI LAVORO	8,2 m
LARGHEZZA MIN. STABILIZZATORI	2,0 m
LARGHEZZA MAX. STABILIZZATORI	3,1 m
ROTAZIONE TORRETTA	370°
ROTAZIONE IDRAULICA DEL CESTELLO	2 x 90°
DIMENSIONE MAX DEL CESTELLO	1,40 x 0,84 x 1,10
PORTATA CESTELLO	250 kg
MASSA COMPLESSIVA VEICOLO	3500 kg

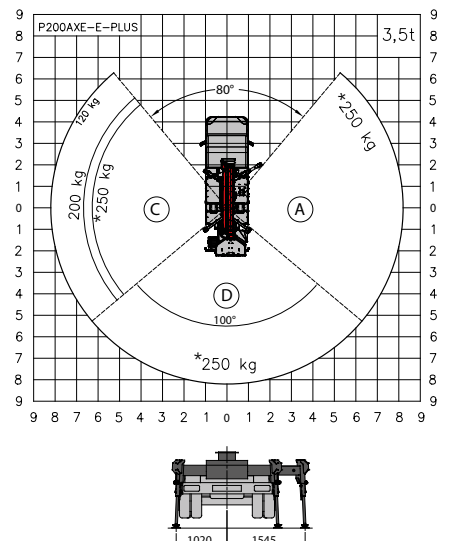
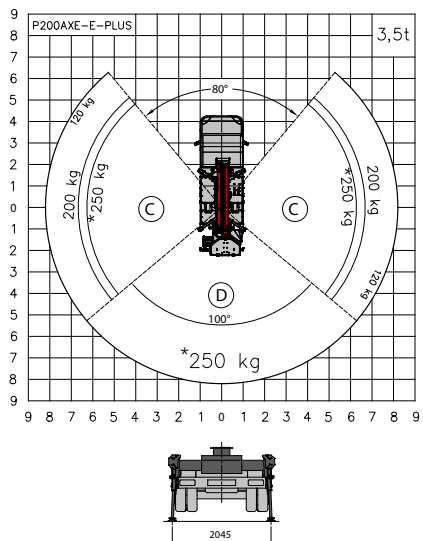
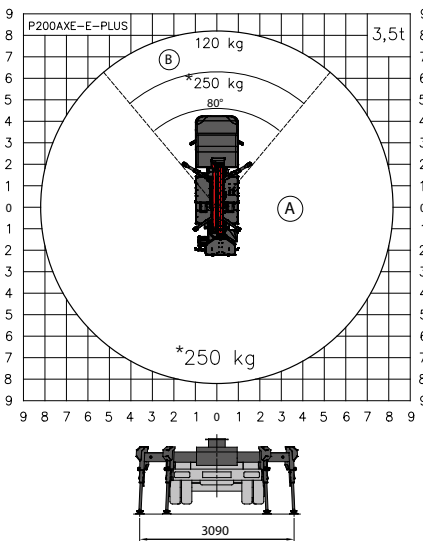
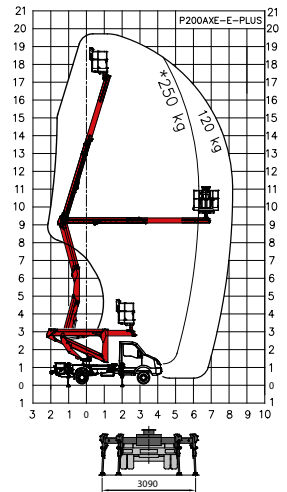
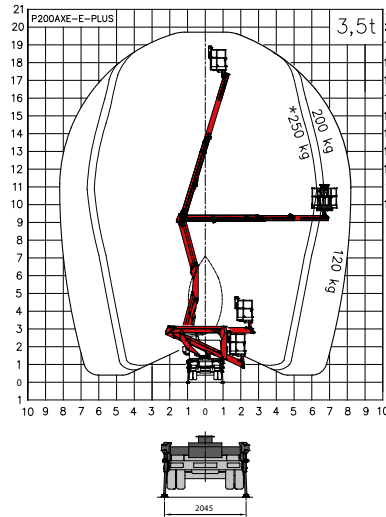
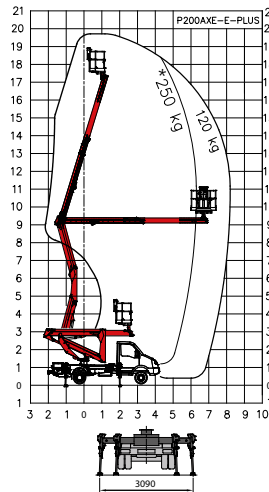
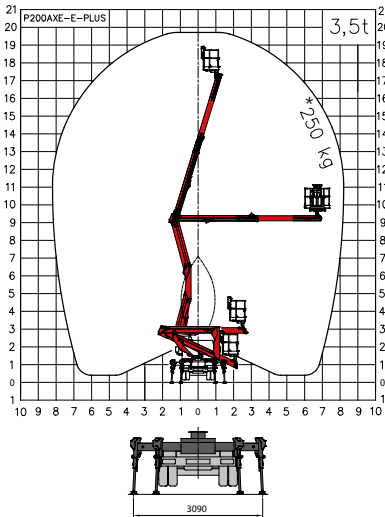

Masse suscettibili ad una variazione +/- 5% Dati tecnici suscettibili ad una variazione +/- 3